



my e-Catalog

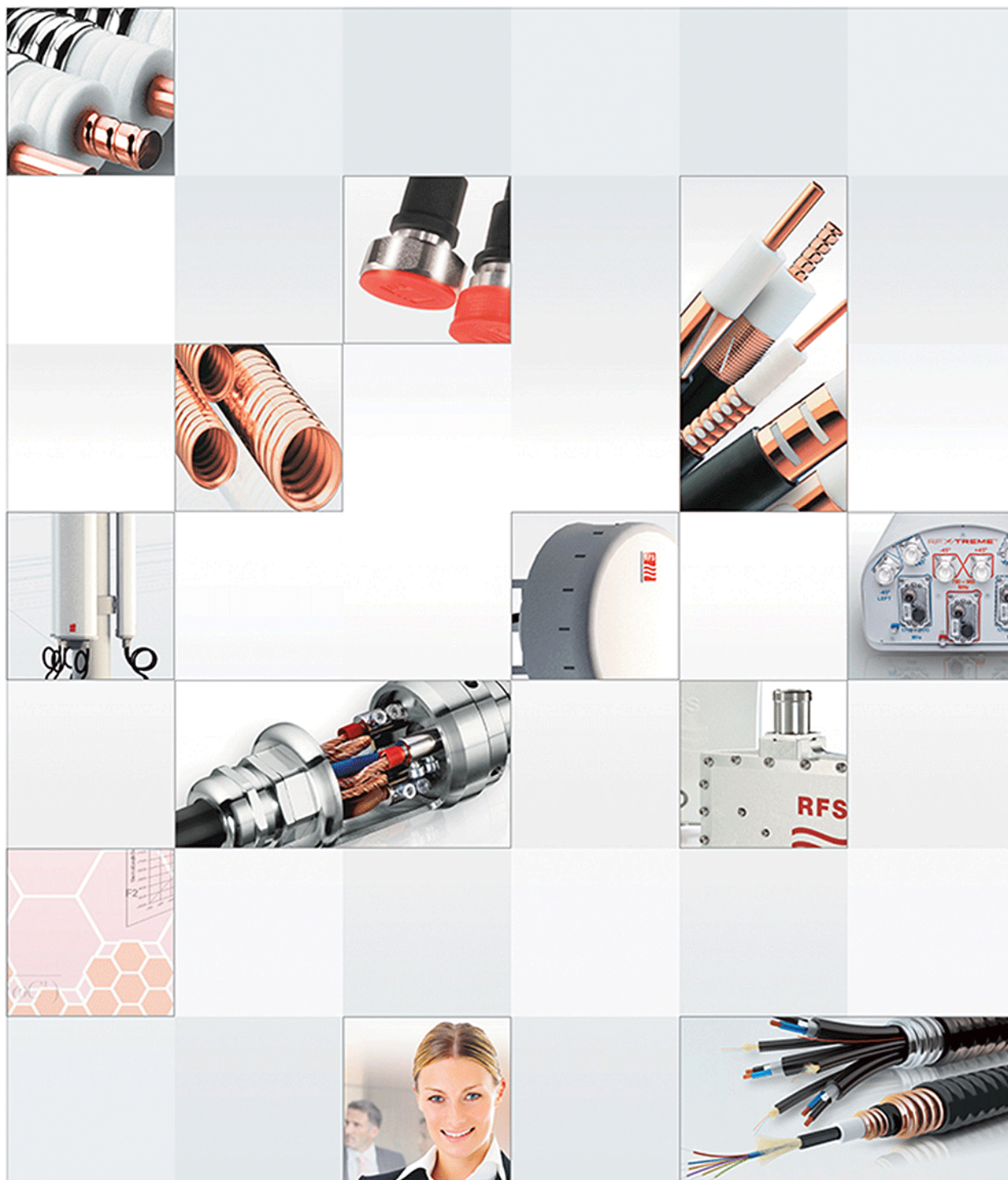

TABLE OF CONTENTS

Product Datasheets

CDS10E-698/2700 10dB Directional Coupler	1
CDS15E-698/2700 15dB Directional Coupler	3
CDS3E-700/2700 3dB Directional Hybrid Coupler	5
CDS7I-700/2700 7dB Directional Coupler	7
I-ATO1-698/2700 Indoor Omnidirectional Antenna 698-2700 MHz	9
I-ATO1-698/2700M Indoor Omnidirectional MIMO Antenna 698-2700 MHz	11
I-ATP1-698/2700 Indoor Panel Antenna 698-2700 MHz	13
I-ATP1-698/2700P Indoor Panel Antenna 698-2700 MHz	15
N-TER-100 Load, N male, 100 Watt	17
N-TER-50 Load, N male, 50 Watt	18
PDS2E-698/2700 2 Way Power Divider	19
PDS3E-698/2700 3 Way Power Divider	21
PDS4E-698/2700 4 Way Power Divider	23



10dB Directional Coupler

Product Description

RFS CDS**E series Directional Coupler has been designed for outdoor applications covering 698 to 2700MHz.

Units couple off a defined fraction of signal from 6 to 20 dB with minimal reflections or loss. The frequency range allows use with antennas and leaky cable systems and in wireless base stations. With minimal solder joints, the dissipative loss has been minimized and reliability enhanced.

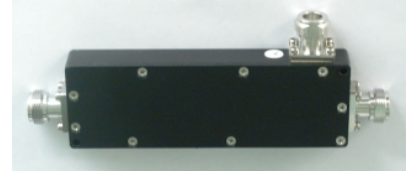

CDS10E-698/2700

Features/Benefits

- 10 dB coupling value
- Low insertion Loss
- High power handling
- Small size, Low weight
- N-female connectors
- Low PIM

Technical Specifications

Product Type	Directional Coupler
Techn. Application	Indoor/Outdoor
Frequency Range, MHz	698 - 2700
Number of Input Ports	1
Number of Output Ports	2
Connector Type	N female
Impedance, Ohm	50
Insertion Loss max., dB	0.7
Max VSWR / R L, dB	1.25 / 19.1
Intermodulation (IM3)	150 dBc with 2x43 dBm tones
Coupling Value, dB	10
Directivity min., dB	20
Coupling Flatness max., dB	±1.0
Total Input Power, W	200
Temperature Range, °C (°F)	-25 to 55 (-13 to 131)
Height, mm (in)	18 (0.71)
Width, mm (in)	58.2 (2.3)
Length, mm (in)	159.4 (6.28)
Weight, kg (lb)	0.24 (0.53)
Environmental Class	IP65

Notes

Other Documentation

All information contained in the present datasheet is subject to confirmation at time of ordering



10dB Directional Coupler

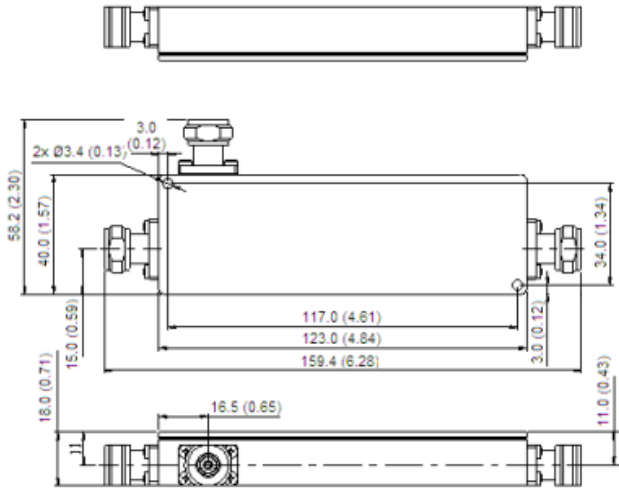

Dimensions mm(inch)

All information contained in the present datasheet is subject to confirmation at time of ordering

15dB Directional Coupler

Product Description

RFS CDS**E series Directional Coupler has been designed for outdoor applications covering 698 to 2700MHz.

Units couple off a defined fraction of signal from 6 to 20 dB with minimal reflections or loss. The frequency range allows use with antennas and leaky cable systems and in wireless base stations. With minimal solder joints, the dissipative loss has been minimized and reliability enhanced.

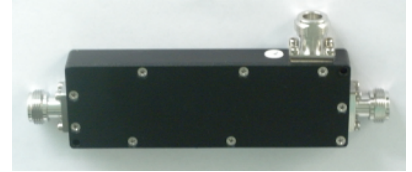

CDS15E-698/2700

Features/Benefits

- 15 dB coupling value
- Low insertion Loss
- High power handling
- Small size, Low weight
- N-female connectors
- Low PIM

Technical Specifications

Product Type	Directional Coupler
Techn. Application	Indoor/Outdoor
Frequency Range, MHz	698 - 2700
Number of Input Ports	1
Number of Output Ports	2
Connector Type	N female
Impedance, Ohm	50
Insertion Loss max., dB	0.4
Max VSWR / R L, dB	1.25 / 19.1
Intermodulation (IM3)	150 dBc with 2x43 dBm tones
Coupling Value, dB	15
Directivity min., dB	20
Coupling Flatness max., dB	±1.0
Total Input Power, W	200
Temperature Range, °C (°F)	-25 to 55 (-13 to 131)
Height, mm (in)	16.5 (0.65)
Width, mm (in)	63.2 (2.49)
Length, mm (in)	159.4 (6.28)
Weight, kg (lb)	0.25 (0.55)
Environmental Class	IP65

Notes**Other Documentation**



15dB Directional Coupler

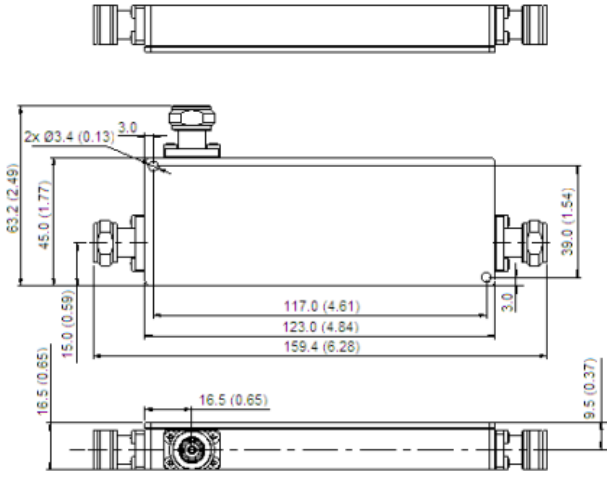

Dimensions mm(inch)

All information contained in the present datasheet is subject to confirmation at time of ordering

3dB Directional Hybrid Coupler

Product Description

The CDS3*-700/2700 hybrid couplers are four-port directional couplers which equally combine two wireless signals and transfer the combined signal to two output ports. The products are designed for wireless services and applications in the frequency band from 700-2700MHz including 2G / 3G / 4G.

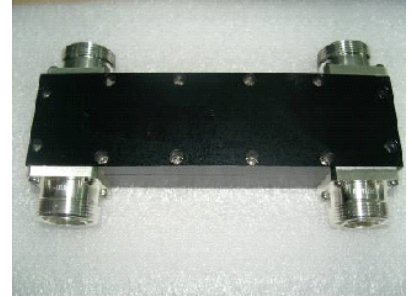

CDS3DE-700/2700 (or similar)

Features/Benefits

- 200 Watt Average Power Rating
- High Reliability
- N female connectors

Technical Specifications

Product Type	Directional Hybrid Coupler
Techn. Application	Indoor, Outdoor
Frequency Range, MHz	700 - 2700
Number of Input Ports	2
Number of Output Ports	2
Connector Type	N female
Impedance, Ohm	50
VSWR / R L, dB	1.2 / 20.8
Intermodulation (IM3)	140 dBc with 2x43 dBm tones
Isolation min, dB	25
Coupling Value, dB	3.0±0.5
Total Input Power, W	200
RF Peak Power, kW	1
Temperature Range, °C (°F)	-25 to 65 (-13 to 149)
Height, mm (in)	41 (1.61)
Width, mm (in)	58.4 (2.3)
Length, mm (in)	194.8 (7.67)
Weight, kg (lb)	0.88 (2.2)
Environmental Class	IP65

Notes**Other Documentation**



3dB Directional Hybrid Coupler

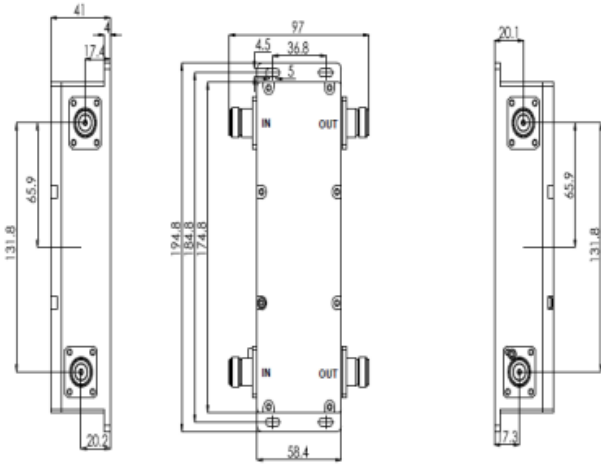

Sketch CDS3E-700/2700

All information contained in the present datasheet is subject to confirmation at time of ordering

7dB Directional Coupler

Product Description

The RFS CDS*I Directional Coupler series provides an RF broadband solution for indoor applications covering all wireless services from 700 to 2700MHz.

The wide frequency range allows to use these couplers for multiband wireless Distributed Antenna Systems (DAS) or in combination with RADIAFLEX® radiating cable products.

The units couple off a defined fraction of the signal from 5 to 40 dB fulfilling highest RF performance requirements by minimizing reflections or RF loss combined with a compact design. As all passive RF products, the CDS*I series ensures highest reliability and maintenance free operation.



CDS7I-700/2700

Features/Benefits

- 7 dB coupling value
- Low insertion Loss
- High power handling
- Small size, Low weight
- N-female connectors

Technical Specifications

Product Type	Directional Coupler
Techn. Application	Indoor
Frequency Range, MHz	700 - 2700
Number of Input Ports	1
Number of Output Ports	2
Connector Type	N female
Impedance, Ohm	50
Insertion Loss max., dB	1.4
Max VSWR / R L, dB	1.3 / 17.7
Intermodulation (IM3)	140 dBc with 2x43 dBm tones
Coupling Value, dB	7
Directivity min., dB	20
Coupling Flatness max., dB	±0.8
Total Input Power, W	200
DC-Path	only through line
Temperature Range, °C (°F)	-25 to 65 (-13 to 149)
Height, mm (in)	16 (0.63)
Width, mm (in)	48.5 (1.91)
Length, mm (in)	150 (5.91)
Weight, kg (lb)	0.17 (0.37)
Environmental Class	Indoor

Notes**Other Documentation**



7dB Directional Coupler

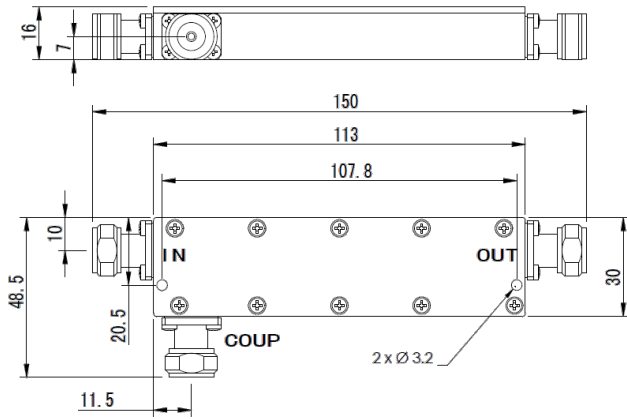

Dimensions mm

All information contained in the present datasheet is subject to confirmation at time of ordering



Indoor Omnidirectional Antenna 698-2700 MHz

Product Description

This omnidirectional antenna is specifically designed for broadband in-building distribution of LTE, GSM, CDMA, PCS, 3G, WiFi, WLAN services. The antenna is constructed from lightweight materials suitable for ceiling mounting. The off-white radome blends easily into most building aesthetics.



Indoor Omnidirectional Antenna

Features/Benefits

- LTE ready (700MHz and 2600MHz bands)
- Input power 100Watt maximum
- Broadband, Low VSWR
- Support current main popular communication system
- Aesthetically designed, compact and light weight
- Off-white (ABS) radome
- Extend a Low Loss Cable

Technical Specifications

Product Type	Omnidirectional Antenna
Application	Indoor
Frequency Range, MHz	698-960 / 1710-2700
Number of Input Ports	1
Connectors	N female
Impedance, Ohm	50
max. VSWR	2.0 @ 698-806MHz 1.5 @ 806-960 and 1710-2700MHz
Total Input Power, W	max. 100
Gain, dBi	2.0 @ 698 - 960MHz 5.0 @ 1700 - 2700MHz
Polarization	Vertical
Horizontal Beamwidth, deg	360
Connector Cable, mm (in)	200 (7.87)
Radome Material	ABS
Radome Color	White
Mounting Hardware included	Ceiling mount, fixed with nut
Temperature Range, °C (°F)	-40 to +60 (-40 to 140)
Height, mm (in)	72 (2.82)
Width, mm (in)	Ø 170 (6.69)
Weight, kg (lb)	0.4 (0.89)
Environmental Class	Indoor

Notes

Other Documentation

All information contained in the present datasheet is subject to confirmation at time of ordering

Indoor Omnidirectional Antenna 698-2700 MHz

Horizontal Plane

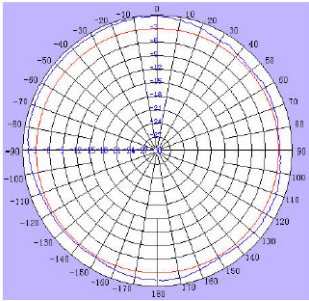

800MHz

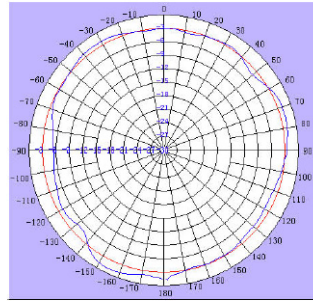

2500MHz

Vertical Plane

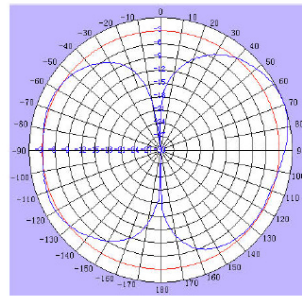

800MHz

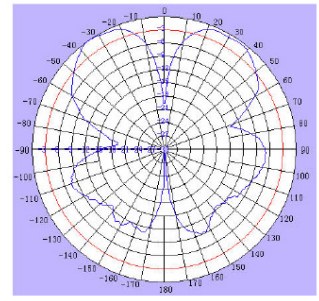

2500MHz

Installation Sketch

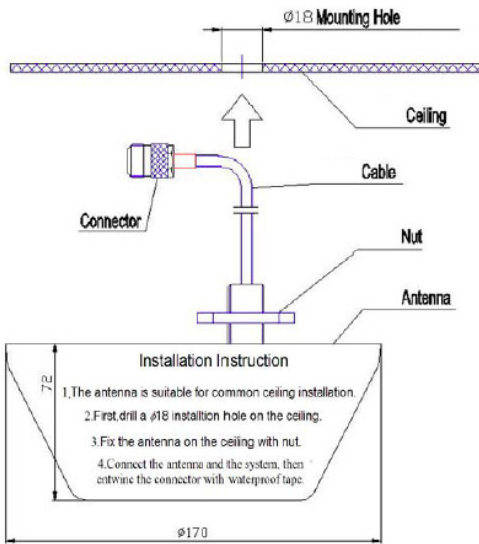

All information contained in the present datasheet is subject to confirmation at time of ordering

Indoor Omnidirectional MIMO Antenna 698-2700 MHz

Product Description

This omnidirectional antenna is specifically designed for broadband in-building MIMO distribution of modern wireless communication systems as LTE, GSM, CDMA, PCS, 3G, WiFi, WLAN services. The antenna ensures highest performance for in-building passive DAS MIMO applications. The antenna is constructed from lightweight materials ideal for easy ceiling mounting. The low profile and off-white radome blends easily into most building aesthetics with minimum visual impact.



Indoor Omnidirectional MIMO Antenna

Features/Benefits

- LTE and MIMO ready (700MHz and 2600MHz bands)
- RF Broadband, supports 698-2700 MHz
- Low VSWR
- Input power 50Watt maximum
- Supports all wireless communication standards
- Aesthetically designed, compact and light weight
- Off-white (ABS) radome
- Ceiling mount, easy to install
- Low loss pigtail with N female connector

Technical Specifications

Product Type	Omnidirectional Antenna
Application	Indoor
Frequency Range, MHz	698-960 / 1710-2700
Number of Input Ports	2
Connectors	N female
Impedance, Ohm	50
max. VSWR	Vertical Polarization max. 1.5 Horizontal Polarization max. 2.0
Total Input Power, W	max. 50
Gain, dBi	Vertical 698 - 960 MHz: 2 ± 1; 1710 - 2700 MHz: 5 ± 1 Horizontal 698 - 960 MHz: 2 ± 1; 1710 - 2700 MHz: 4 ± 1
Polarization	Vertical: black cable Horizontal: yellow cable
Connector Cable, mm (in)	200 (7.87)
Radome Material	ABS
Radome Color	White
Mounting Hardware included	Ceiling mount, fixed with nut
Temperature Range, °C (°F)	-35 to +60 (-31 to 140)
Height, mm (in)	175 (6.89)
Width, mm (in)	Ø 320 (12.6)
Weight, kg (lb)	1.0 (2.21)
Environmental Class	Indoor

Notes

Isolation: between Horizontal and Vertical Polarization ≥ 20 dB

Other Documentation



Indoor Omnidirectional MIMO Antenna 698-2700 MHz

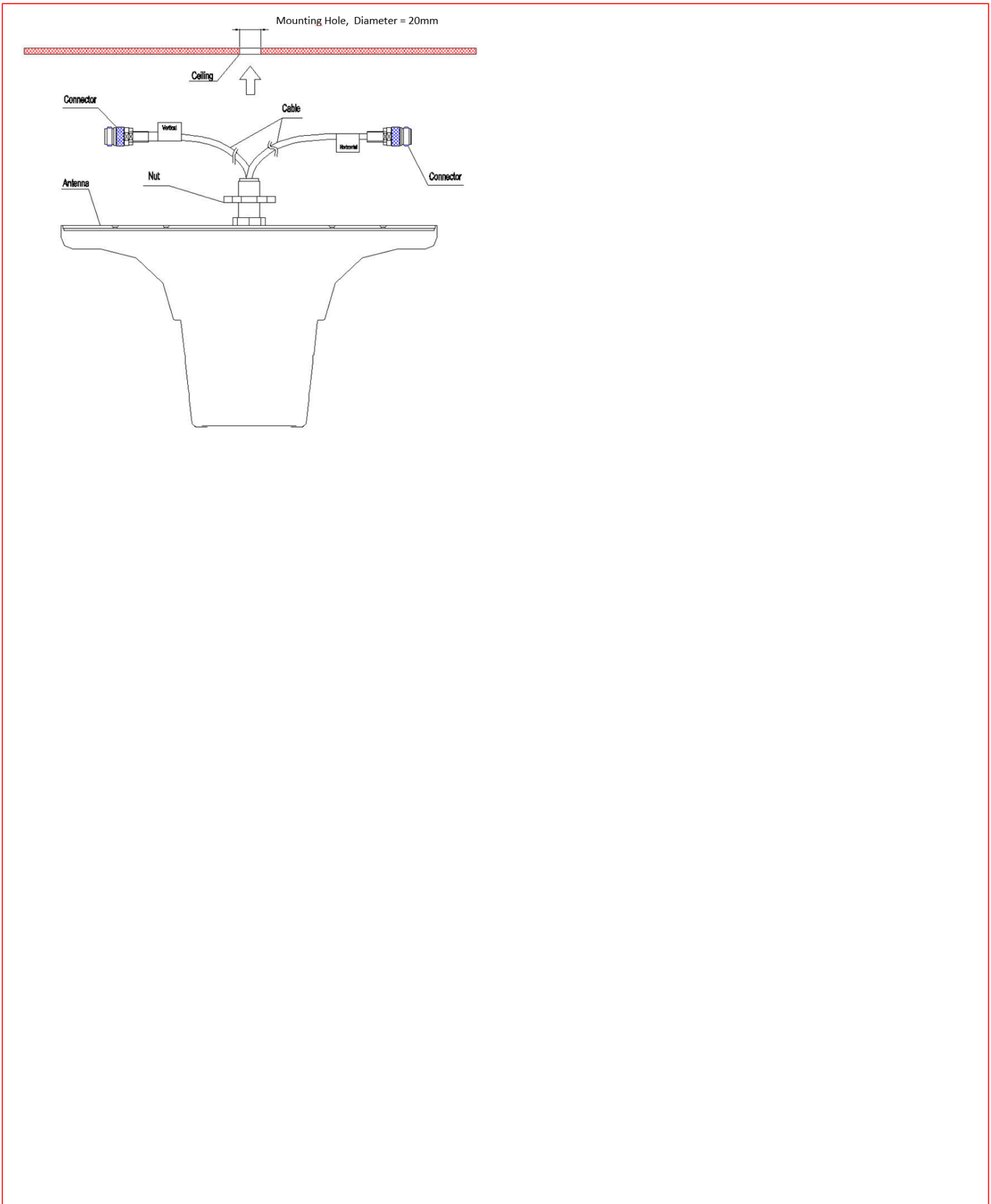

All information contained in the present datasheet is subject to confirmation at time of ordering

Indoor Panel Antenna 698-2700 MHz

Product Description

This panel antenna is specifically designed for broadband in-building distribution of LTE/CDMA800/GSM900/GSM1800/3G and WLAN services. The antenna is constructed from lightweight materials suitable for wall mounting. The off-white radome blends easily into most building aesthetics.



Indoor Panel Antenna

Features/Benefits

- LTE ready (700MHz and 2600MHz bands)
- Broadband, coverage 698 to 2700MHz
- UV stable ABS radome
- Aesthetically designed, compact and light weight
- Low VSWR, High gain, Stable performance
- NF connector with pigtail

Technical Specifications

Product Type	Panel Antenna
Application	Indoor
Frequency Range, MHz	698-960 / 1710-2700
Number of Input Ports	1
Connectors	N female
Impedance, Ohm	50
max. VSWR	2.0 @ 698-960MHz 1.5 @ 1710-2700MHz
Total Input Power, W	max. 50
Gain, dBi	7.0 @ 698 - 960MHz 10.0 @ 1710 - 2700MHz
Front-to-Back Ratio, dB	7.0 @ 698-960MHz 10.0 @ 1710-2700MHz
Polarization	Vertical
Horizontal Beamwidth, deg	70 @ 698-960MHz 60 @ 1710-2700MHz
Vertical Beamwidth, deg	55 @ 698-960MHz 45 @ 1710-2700MHz
Connector Cable, mm (in)	150 (5.90)
Radome Material	ABS
Radome Color	White
Mounting Hardware included	Wall bracket, screws
Temperature Range, °C (°F)	-40 to +60 (-40 to 140)
Height, mm (in)	44 (1.73)
Width, mm (in)	180 (7.09)
Length, mm (in)	210 (8.27)
Weight, kg (lb)	0.4 (0.89)
Environmental Class	Indoor

Notes**Other Documentation**



Indoor Panel Antenna 698-2700 MHz

Horizontal

880MHz

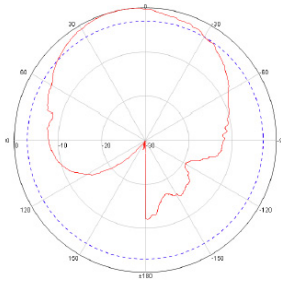

2500MHz

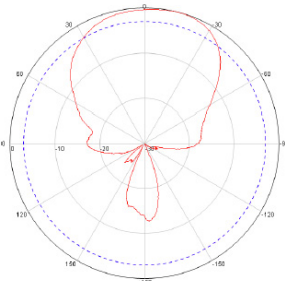

Vertical

880MHz

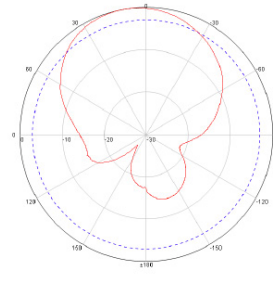

2500MHz

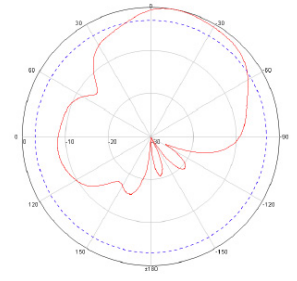

Installation Sketch

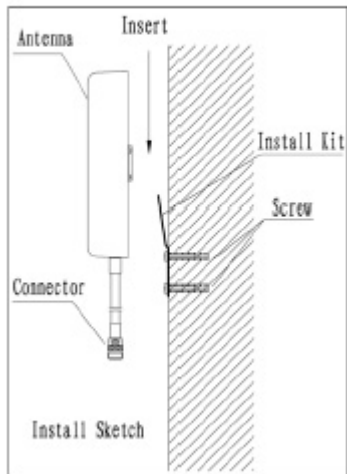

All information contained in the present datasheet is subject to confirmation at time of ordering



Indoor Panel Antenna 698-2700 MHz

Product Description

This panel antenna is specifically designed for broadband in-building distribution of modern wireless communication systems as LTE, GSM, CDMA, PCS, 3G, WiFi, WLAN services. The antenna ensures highest performance for in-building passive DAS applications avoiding passive intermodulation products due to the PIM optimized design. The antenna is constructed from lightweight materials ideal for easy ceiling mounting. The low profile and off-white radome blends easily into most building aesthetics with minimum visual impact.



Indoor Panel Antenna

Features/Benefits

- LTE ready (700MHz and 2600MHz bands)
- Highest PIM performance
- RF Broadband, supports 698-2700 MHz
- Low VSWR
- Input power 50Watt maximum
- Supports all wireless communication standards
- Aesthetically designed, compact and light weight
- Off-white (ABS) radome
- Wall mount, easy to install
- Low loss pigtail with N female connector

Technical Specifications

Product Type	Panel Antenna
Application	Indoor
Frequency Range, MHz	698-960 / 1710-2700
Number of Input Ports	1
Connectors	N female
Impedance, Ohm	50
max. VSWR	2.0 @ 698-960MHz 1.5 @ 1710-2700MHz
Intermodulation (IM3)	-140 dBc with 2 x 33 dBm
Total Input Power, W	max. 50
Gain, dBi	6.0 ±1 @ 698 - 960MHz 8.0 ±1 @ 1710 - 2700MHz
Front-to-Back Ratio, dB	8.0 @ 698-960MHz 10.0 @ 1710-2700MHz
Polarization	Vertical
Horizontal Beamwidth, deg	90 ±15 @ 698-960 MHz 70 ±15 @ 1710-2700 MHz
Vertical Beamwidth, deg	65 @ 698-960 MHz 60 @ 1710-2700 MHz
Connector Cable, mm (in)	150 (5.90)
Radome Material	ABS
Radome Color	White
Mounting Hardware included	Wall bracket, screws
Temperature Range, °C (°F)	-40 to +60 (-40 to 140)

All information contained in the present datasheet is subject to confirmation at time of ordering



Indoor Panel Antenna 698-2700 MHz

Height, mm (in)	50 (1.97)
Width, mm (in)	170 (6.69)
Length, mm (in)	290 (11.42)
Weight, kg (lb)	0.7 (1.54)
Environmental Class	Indoor

Notes

Other Documentation

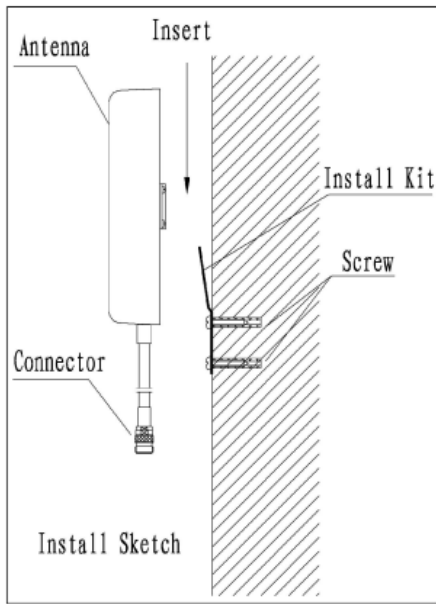
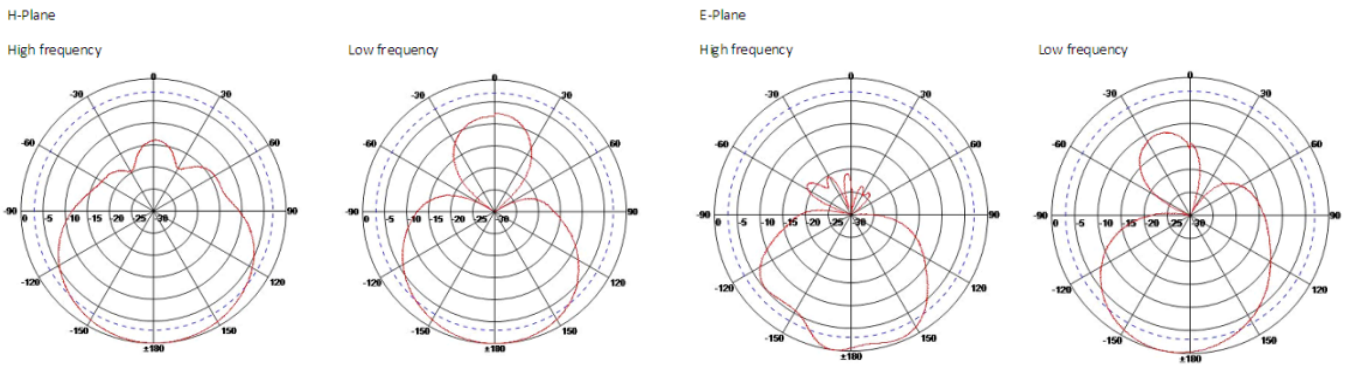

All information contained in the present datasheet is subject to confirmation at time of ordering



Load, N male, 100 Watt

Product Description

The N-TER Series are coaxial loads, which operate from DC up to 3.0 GHz.

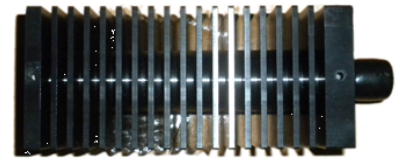

sample is N-TER-100

Features/Benefits

- Finned termination
- Low VSWR
- RoHS compliant
- Designed for wireless applications

Technical Specifications

Product Type	Load
Techn. Application	Indoor
Frequency Range, MHz	DC-3.000
Input Connector Type	N male
Impedance, Ohm	50
Max. VSWR / Return Loss, dB	1.2 / 20.8
Total Input Power, W	100
Temperature Range, °C (°F)	-40 to 65 (-40 to 149)
Height, mm (in)	182.5 (7.19)
Width, mm (in)	70 (2.76)
Length, mm (in)	70 (2.76)
Environmental Class	Indoor

Notes

Other Documentation

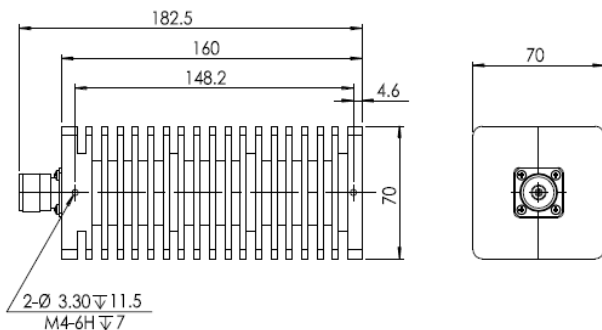

All information contained in the present datasheet is subject to confirmation at time of ordering



Load, N male, 50 Watt

Product Description

The N-TER Series are coaxial loads, which operate from DC up to 3.0 GHz.



sample is N-TER-50

Features/Benefits

- Finned termination
- Low VSWR
- RoHS compliant
- Designed for wireless applications

Technical Specifications

Product Type	Load
Techn. Application	Indoor
Frequency Range, MHz	DC-3.000
Input Connector Type	N male
Impedance, Ohm	50
Max. VSWR / Return Loss, dB	1.2 / 20.8
Total Input Power, W	50
Temperature Range, °C (°F)	-40 to 65 (-40 to 149)
Height, mm (in)	127 (4.99)
Diameter, mm (in)	50 (1.97)
Environmental Class	Indoor

Notes

Other Documentation

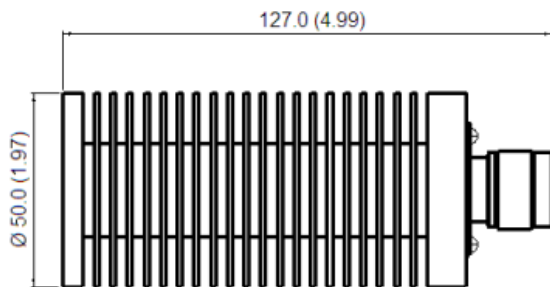

All information contained in the present datasheet is subject to confirmation at time of ordering



2 Way Power Divider

Product Description

This PDS*E series are Power Splitters, designed to evenly split high power cellular signals with minimal reflections or loss. They are specified to cover 698- 2700 MHz. The wide frequency ranges of these models allow use with multiband antennas and leaky cable systems. With few solder joints and an air dielectric, the loss is minimal and reliability enhanced.



PDS2E-698/2700

Features/Benefits

- Multiple-Band Frequency Ranges
- 200 Watt Power Rating
- High Reliability
- Low Cost Design for Outdoor Application
- Low Specified PIM
- N-female Connectors

Technical Specifications

Product Type	Power Divider
Techn. Application	Indoor/Outdoor
Frequency Range, MHz	698 - 2700
Number of Input Ports	1
Number of Output Ports	2
Connectors	N-female
Impedance, Ohm	50
Max. VSWR / Return Loss, dB	1.25 / 19.1
Split Loss, dB	3.3
Max Ripple, dB	0.3
Intermodulation (IM3)	-150 dBc with 2x43 dBm tones
Total Input Power, W	200
Temperature Range, °C (°F)	-25 to +65 (-13 to +149)
Height (Less Connectors), mm (in)	25 (0.98)
Width (Less Connectors), mm (in)	61 (2.4)
Length (Less Connectors), mm (in)	216 (8.5)
Weight, kg (lb)	0.237 (0.52)
Environmental Class	IP65

Notes**Other Documentation**

All information contained in the present datasheet is subject to confirmation at time of ordering



2 Way Power Divider

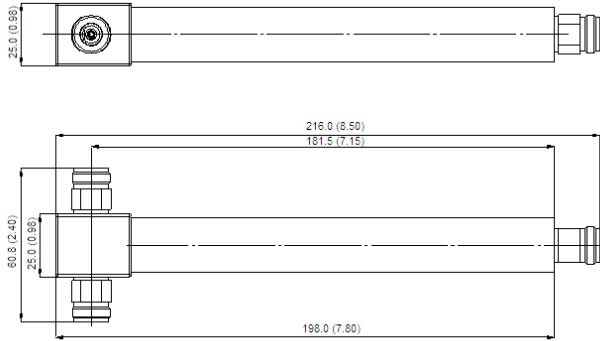

Dimensions mm(inch)

All information contained in the present datasheet is subject to confirmation at time of ordering

3 Way Power Divider

Product Description

This PDS*E series are Power Splitters, designed to evenly split high power cellular signals with minimal reflections or loss. They are specified to cover 698- 2700 MHz. The wide frequency ranges of these models allow use with multiband antennas and leaky cable systems. With few solder joints and an air dielectric, the loss is minimal and reliability enhanced.



PDS3E-698/2700

Features/Benefits

- Multiple-Band Frequency Ranges
- 200 Watt Power Rating
- High Reliability
- Low Cost Design for Outdoor Application
- Low Specified PIM
- N-female Connectors

Technical Specifications

Product Type	Power Divider
Techn. Application	Indoor/Outdoor
Frequency Range, MHz	698 - 2700
Number of Input Ports	1
Number of Output Ports	3
Connectors	N-female
Impedance, Ohm	50
Max. VSWR / Return Loss, dB	1.25 / 19.1
Split Loss, dB	5.1
Max Ripple, dB	0.3
Intermodulation (IM3)	-150 dBc with 2x43 dBm tones
Total Input Power, W	200
Temperature Range, °C (°F)	-25 to +65 (-13 to +149)
Height (Less Connectors), mm (in)	25 (0.98)
Width (Less Connectors), mm (in)	61 (2.4)
Length (Less Connectors), mm (in)	236.7 (9.31)
Weight, kg (lb)	0.272 (0.599)
Environmental Class	IP65

Notes**Other Documentation**



3 Way Power Divider

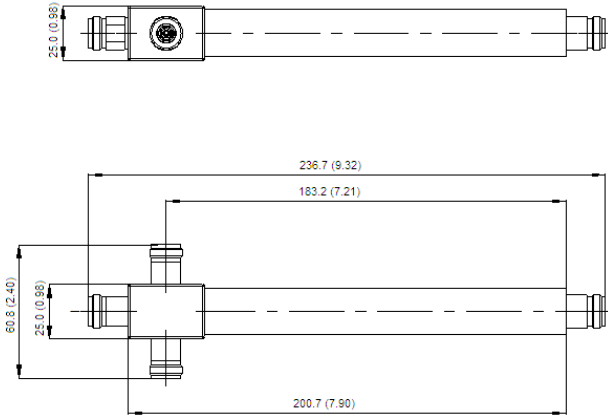

Dimensions mm(inch)

All information contained in the present datasheet is subject to confirmation at time of ordering

4 Way Power Divider

Product Description

This PDS*E series are Power Splitters, designed to evenly split high power cellular signals with minimal reflections or loss. They are specified to cover 698- 2700 MHz. The wide frequency ranges of these models allow use with multiband antennas and leaky cable systems. With few solder joints and an air dielectric, the loss is minimal and reliability enhanced.



PDS4E-698/2700

Features/Benefits

- Multiple-Band Frequency Ranges
- 200 Watt Power Rating
- High Reliability
- Low Cost Design for Outdoor Application
- Low Specified PIM
- N-female Connectors

Technical Specifications

Product Type	Power Divider
Techn. Application	Indoor/Outdoor
Frequency Range, MHz	698 - 2700
Number of Input Ports	1
Number of Output Ports	4
Connectors	N-female
Impedance, Ohm	50
Max. VSWR / Return Loss, dB	1.25 / 19.1
Split Loss, dB	6.4
Max Ripple, dB	0.3
Intermodulation (IM3)	-150 dBc with 2x43 dBm tones
Total Input Power, W	200
Temperature Range, °C (°F)	-25 to +65 (-13 to +149)
Height (Less Connectors), mm (in)	43 (1.69)
Width (Less Connectors), mm (in)	61 (2.4)
Length (Less Connectors), mm (in)	239.4 (9.425)
Weight, kg (lb)	0.295 (0.65)
Environmental Class	IP65

Notes**Other Documentation**



4 Way Power Divider

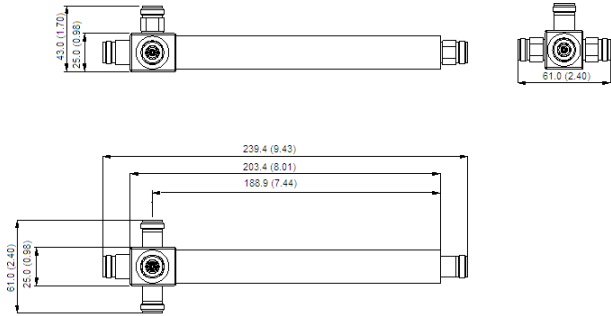

Dimensions mm(inch)

All information contained in the present datasheet is subject to confirmation at time of ordering