

ANTENNAS FOR CELLULAR NETWORKS

TwinLine | UltraLine | StreamLine
High Band | Tri-Sector | Small Cell



Performance-Driven Technology for Cellular Networks



ONE SOURCE. GLOBAL SITE SOLUTIONS™

Amphenol is a leading global solutions provider for wireless infrastructure systems. Whether it's a complex base station, a small DAS network or an In-Building System, we supply over 6,000 products with best-in-class performance.

With Amphenol, OEMs and operators have the convenience of a one-stop shop, not only for quality antennas, but for transmission line products like feeder cable, hybrid fiber, surge arrestors and connectors as well as RF peripherals like TMAs, combiners, couplers and splitters. All products support next generation wireless communication systems.

Amphenol offers years of expertise in product design, development and engineering along with an unparalleled commitment to customer service.



Contents

Antennas for Cellular Networks



4

4 TwinLine Panel Antennas

Quad antennas with two multiband arrays housed in an optimally designed package for low windload. Ideal for site/technology sharing.



6

6 UltraLine Panel Antennas

Evolutionary antenna configuration that can allow up to five (5) different bands in one compact arrangement. Perfect for future-proofing a base station site.

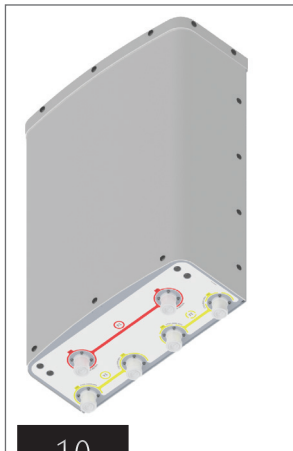

10

8 StreamLine Panel Antennas

Evolutionary antenna configuration that can allow up to five (5) different bands. Designed for enhanced MIMO performance.

9 High Band Panel Antennas

Ultra-wideband antennas designed to handle 2G, 3G networks and MIMO configurations for LTE on 1.7 / 2.1 / 2.6 networks.

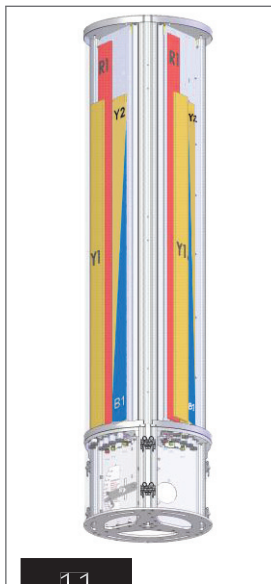

11

10 Small Cell Antennas

Innovative wide band, dual band and tri band antenna configurations allow one distributed antenna system to serve multiple service providers with minimum visual impact.

11 Tri-Sector Antennas

Three-Sector antennas inside a small, low visual impact cylindrical enclosure. Discretely deployed as flag poles, roof-top vents, street lamps or telephone poles.

13 RET Control Systems

Amphenol's patented fully integrated RET control units add no additional length to the antenna.



15

15 Site Solutions

A comprehensive suite of solutions for virtually all applications, with product available from the top of the tower to the base station.

TwinLine Panel Antennas

Quad antennas with two multiband arrays housed in an optimally designed package for low windload. Ideal for site/technology sharing.

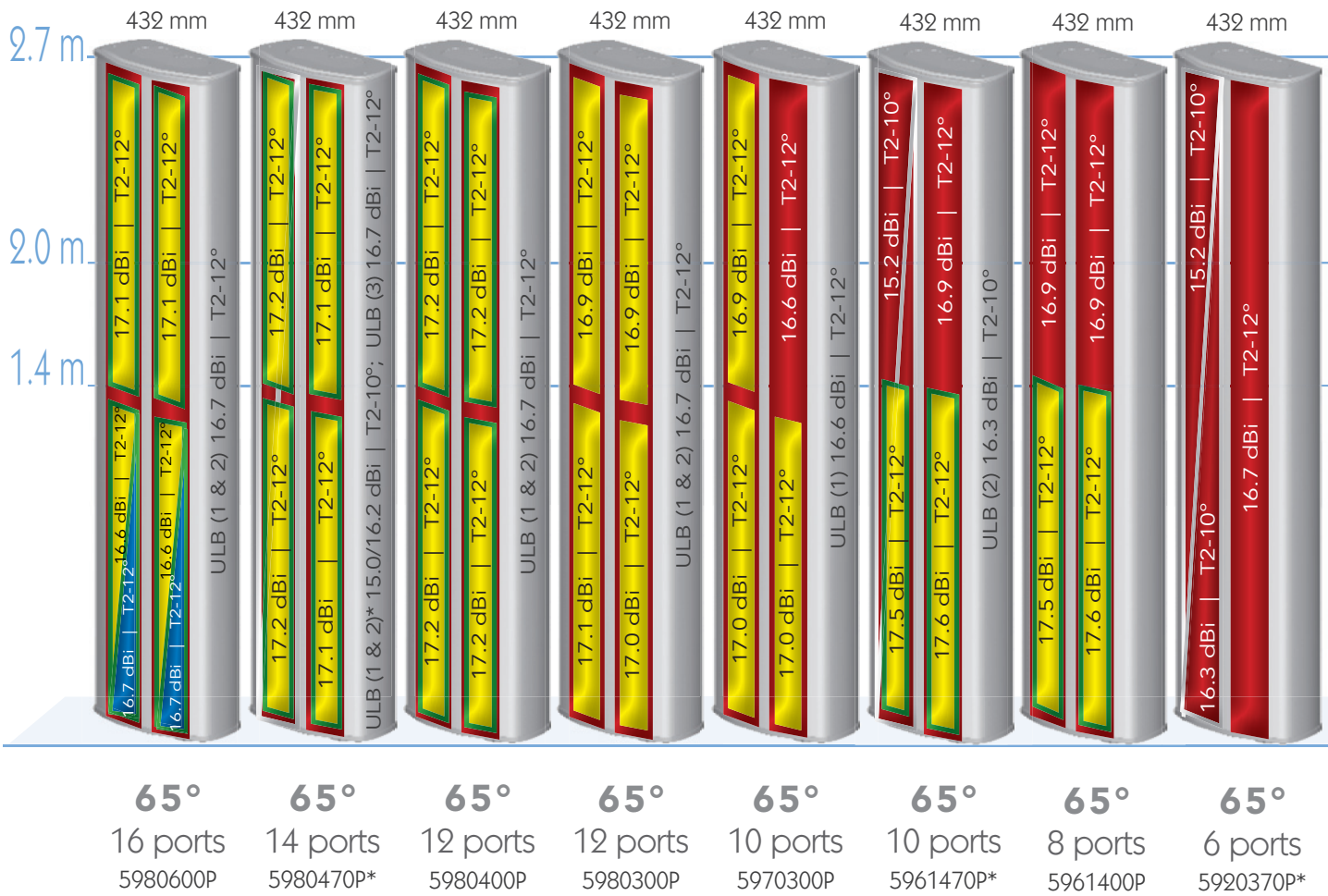

Ultra Low Band (ULB) 698-960 MHz

Ultra Wide Band Array (UWB) 1695-2690 MHz

*Filtered Ultra Low Band (ULB) 2 Ports 698-803 MHz
2 Ports 880-960 MHz

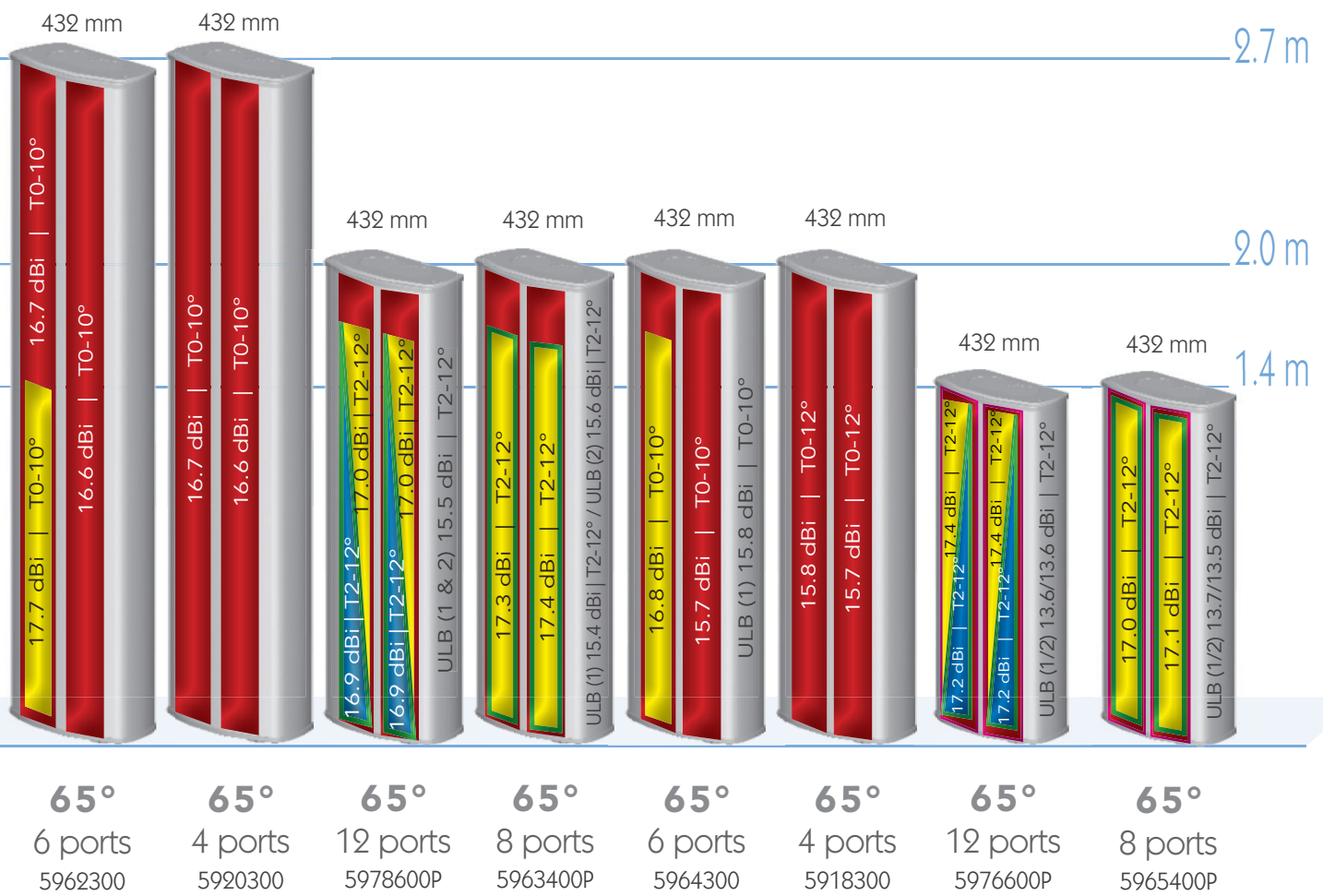

TwinLine Panel Antennas

 Mega Wide Band Array (MWB) 1427-2690 MHz

 Filtered Array 2 Ports 1427-2180 MHz
2 Ports 2490-2690 MHz

UltraLine Panel Antennas

Evolutionary antenna configuration that can allow up to five (5) different bands in one compact arrangement. Perfect for future-proofing a base station site.

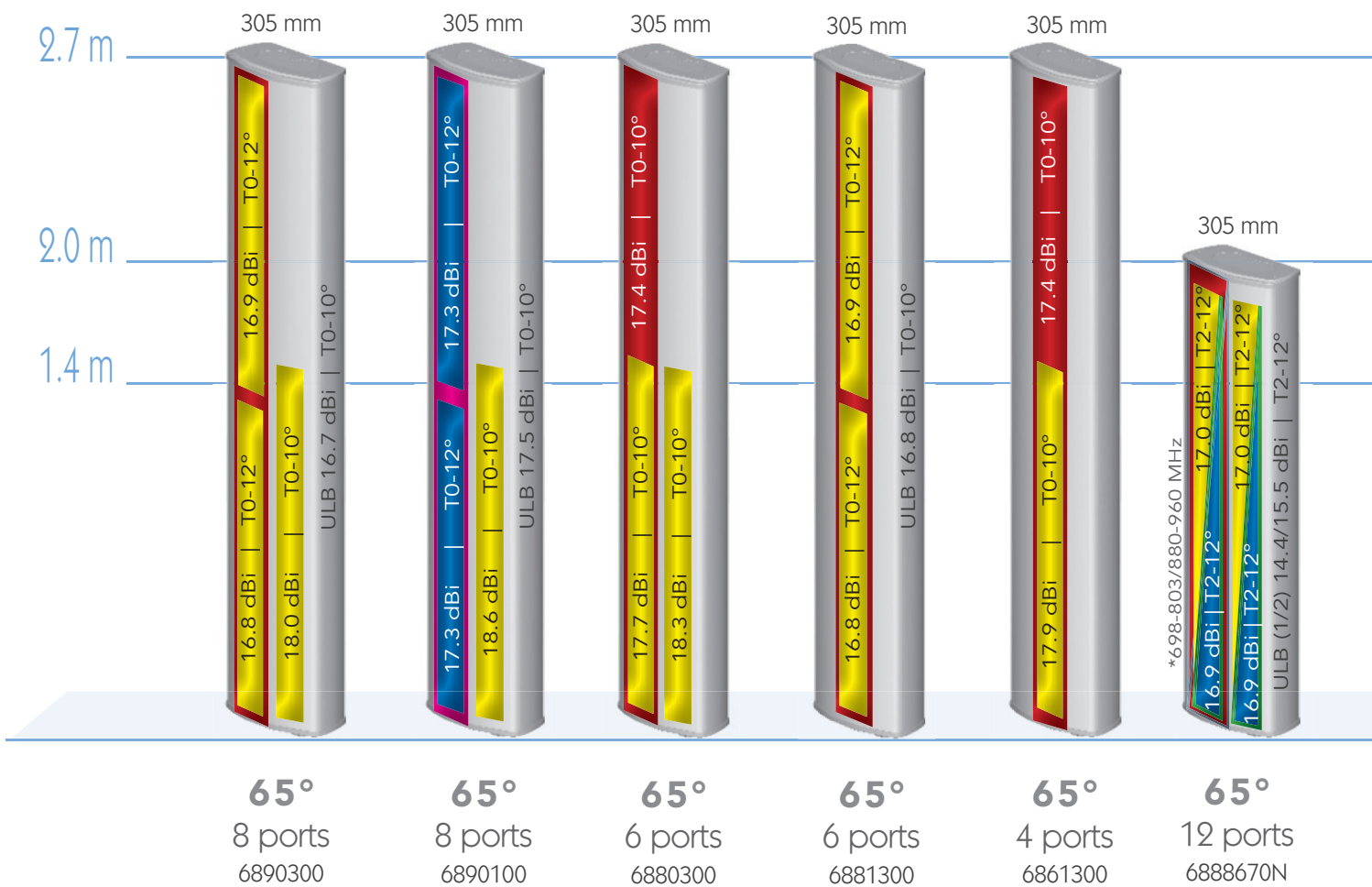

 Extended Low Band (ELB) 790-960 MHz

 Wide Band Array (WB) 1695-2180 MHz

 Ultra Low Band (ULB) 698-960 MHz

 Mega Wide Band Array (MWB) 1427-2690 MHz

2.7 m

2.0 m

1.4 m

UltraLine Panel Antennas

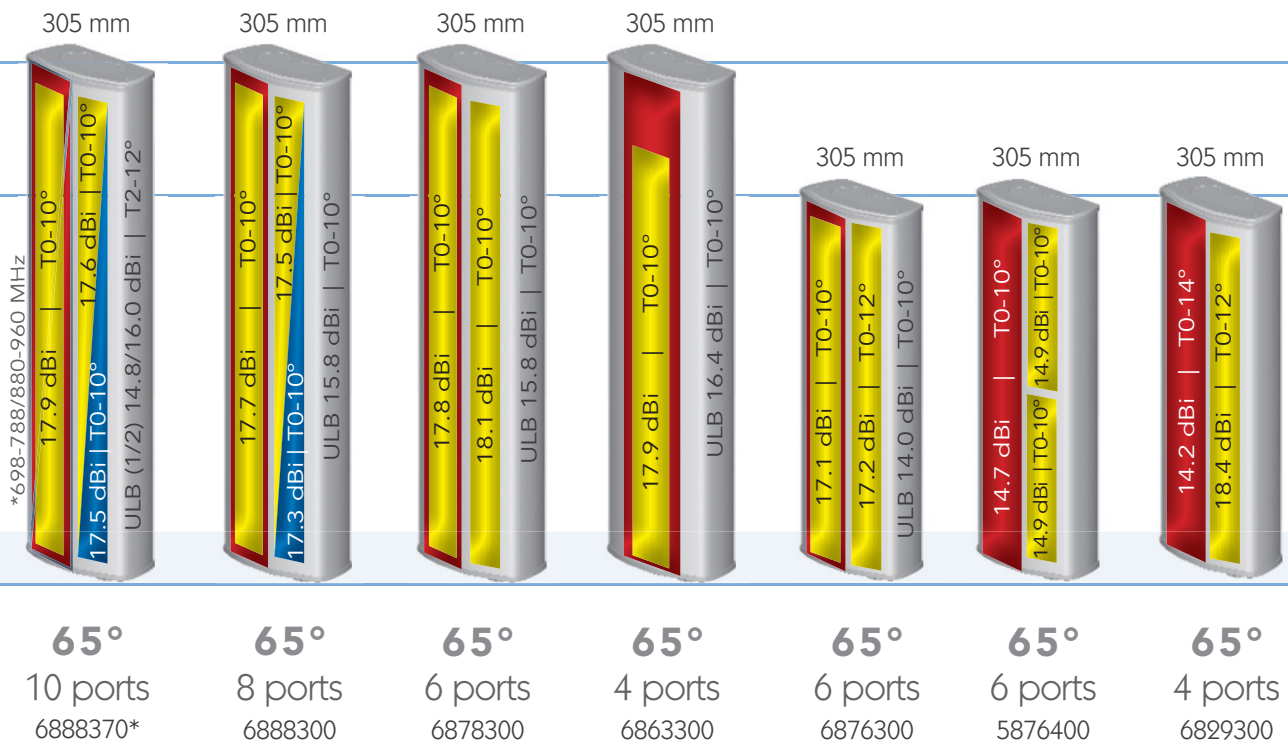

 Ultra Wide Band Array (UWB) 1695-2690 MHz

 Filtered Array 2 Ports 1695-2180 MHz
2 Ports 2490-2690 MHz

 *Filtered Ultra Low Band (ULB)
2 Ports 698-803 or 698-788 MHz
2 Ports 880-960 MHz

 Filtered Array 2 Ports 1427-2180 MHz
2 Ports 2490-2690 MHz

StreamLine Panel Antennas

Evolutionary antenna configuration that can allow up to five (5) different bands. Designed for enhanced MIMO performance.

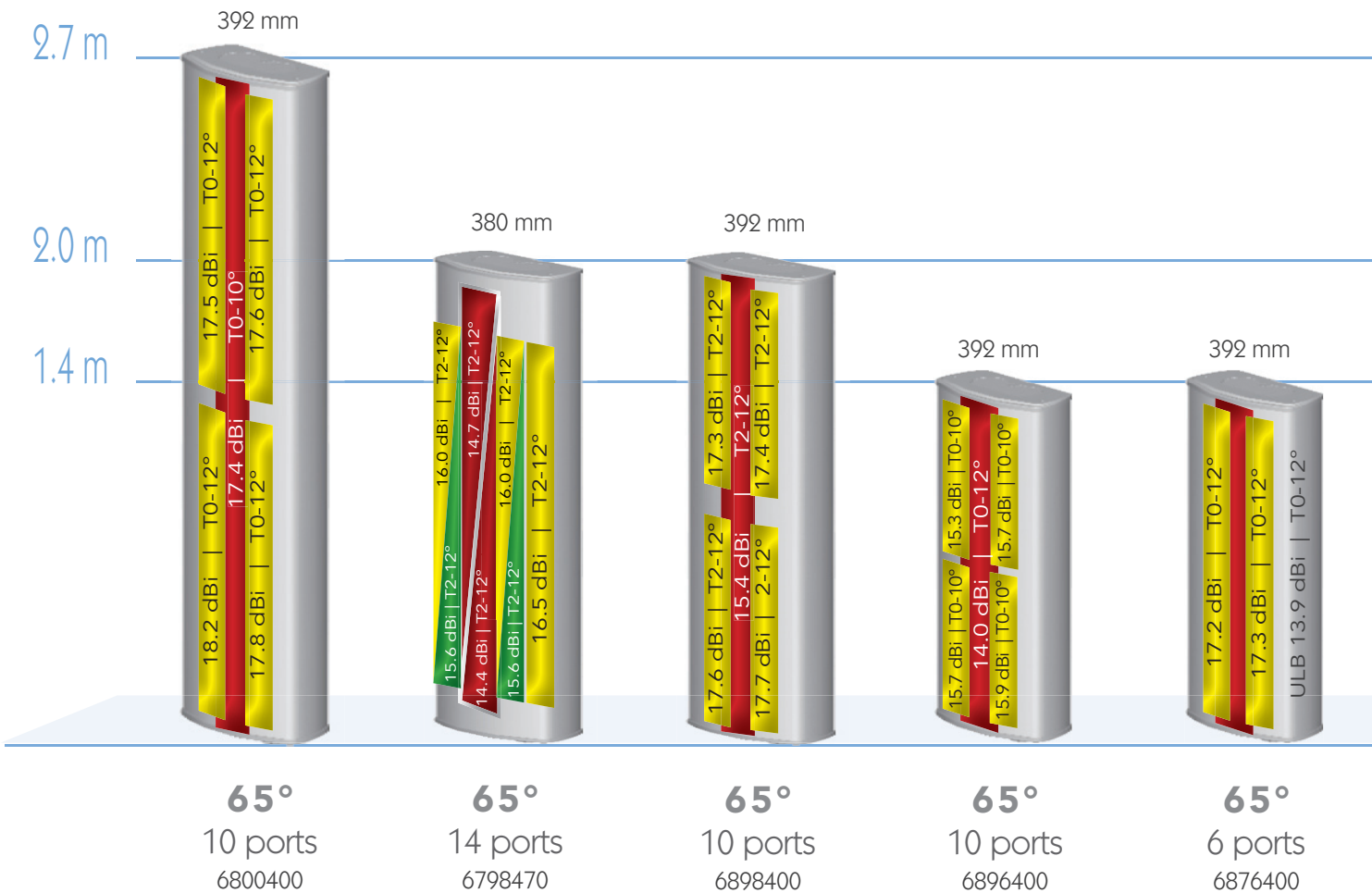

 Ultra Low Band (ULB) 698-960 MHz

 Ultra Wide Band Array (UWB) 1695-2690 MHz

 *Filtered Ultra Low Band (ULB)
 2 Ports 698-788 MHz
 2 Ports 880-960 MHz

 Filtered Array 2 Ports 1427-2180 MHz
 2 Ports 2490-2690 MHz

High Band Panel Antennas

Ultra-wideband antennas designed to handle 2G, 3G networks and MIMO configurations for LTE on 1.7 / 2.1 / 2.6 networks.



 Filtered Array 2 Ports 1695-2180 MHz
2 Ports 2490-2690 MHz

 Ultra Wide Band Array (UWB) 1695-2690 MHz

Tri-Sector Antennas

Three-Sector antennas inside a small, low visual impact cylindrical enclosure. Discretely deployed as flag poles, roof-top vents, street lamps or telephone poles.

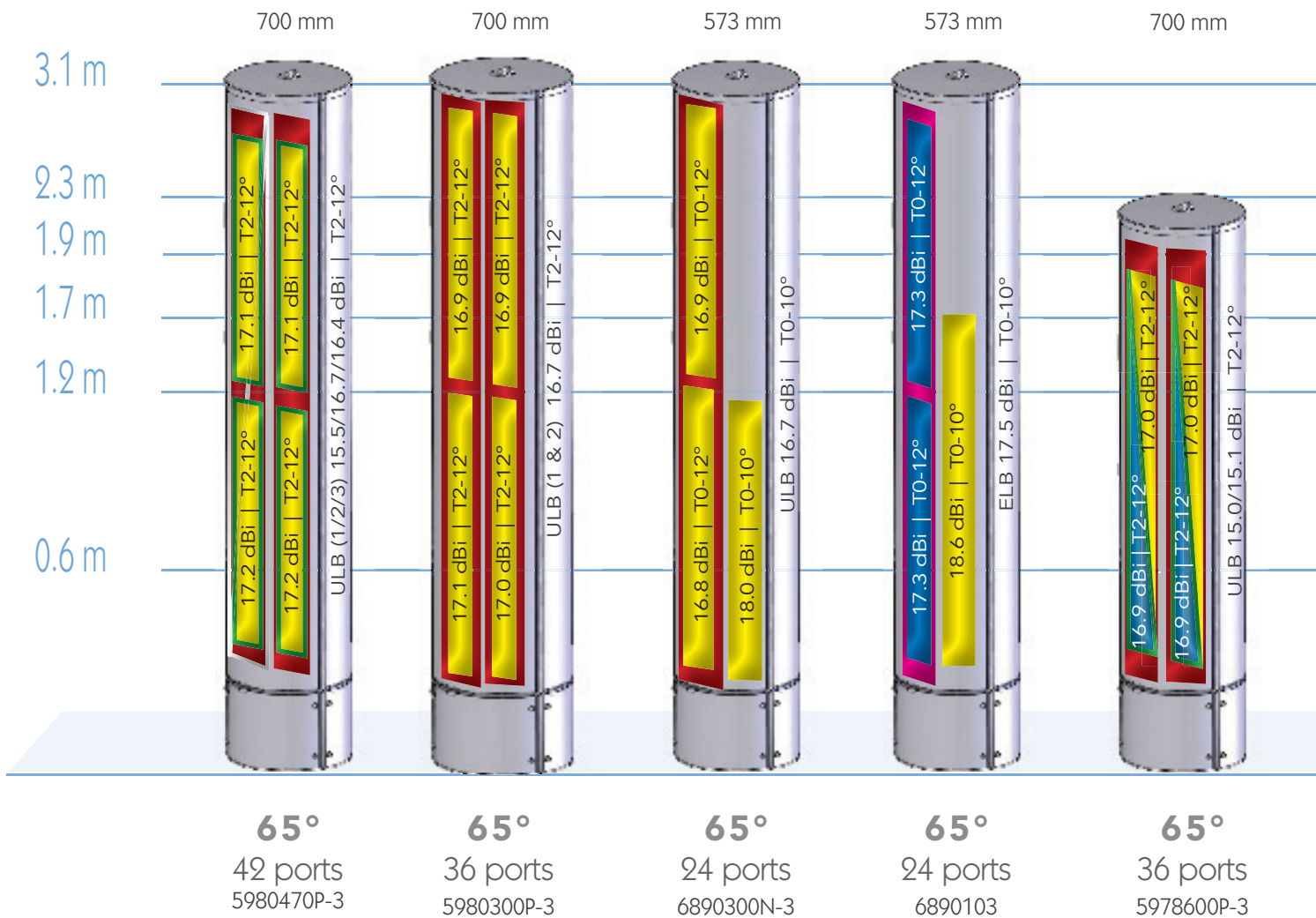

Extended Low Band (ELB) 790-960 MHz



Wide Band Array (WB) 1695-2180 MHz



Ultra Low Band (ULB) 698-960 MHz



*Filtered Ultra Low Band (ULB) 2 Ports 698-788 MHz
2 Ports 880-960 MHz

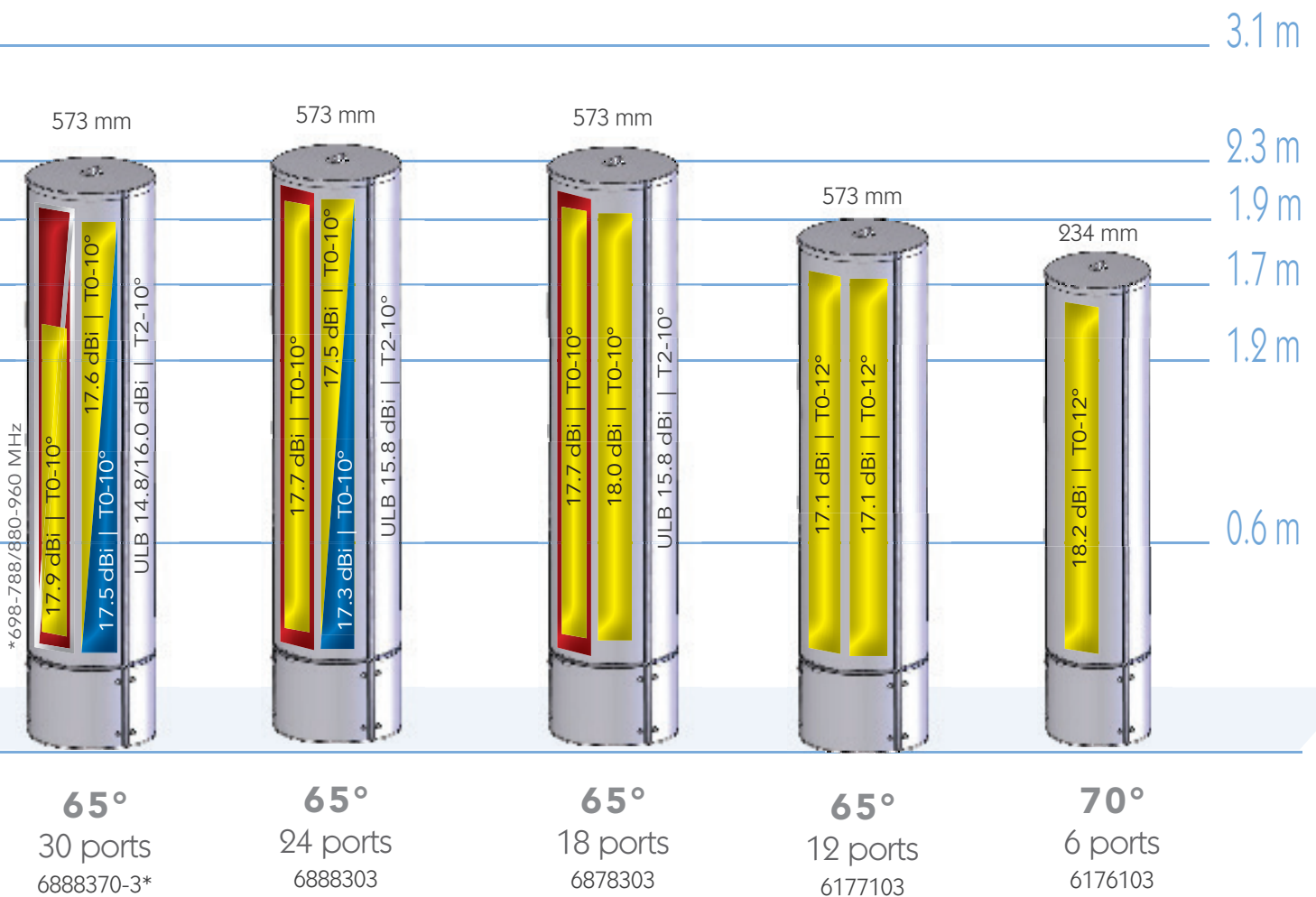

Tri-Sector Antennas

 Ultra Wide Band Array (UWB) 1695-2690 MHz

 Filtered Array 2 Ports 1695-2180 MHz
2 Ports 2490-2690 MHz

 Filtered Array 2 Ports 1427-2180 MHz
2 Ports 2490-2690 MHz

Small Cell Panel Antennas

Innovative wide band, dual band and tri band antenna configurations allow one distributed antenna system to serve multiple service providers with minimum visual impact.

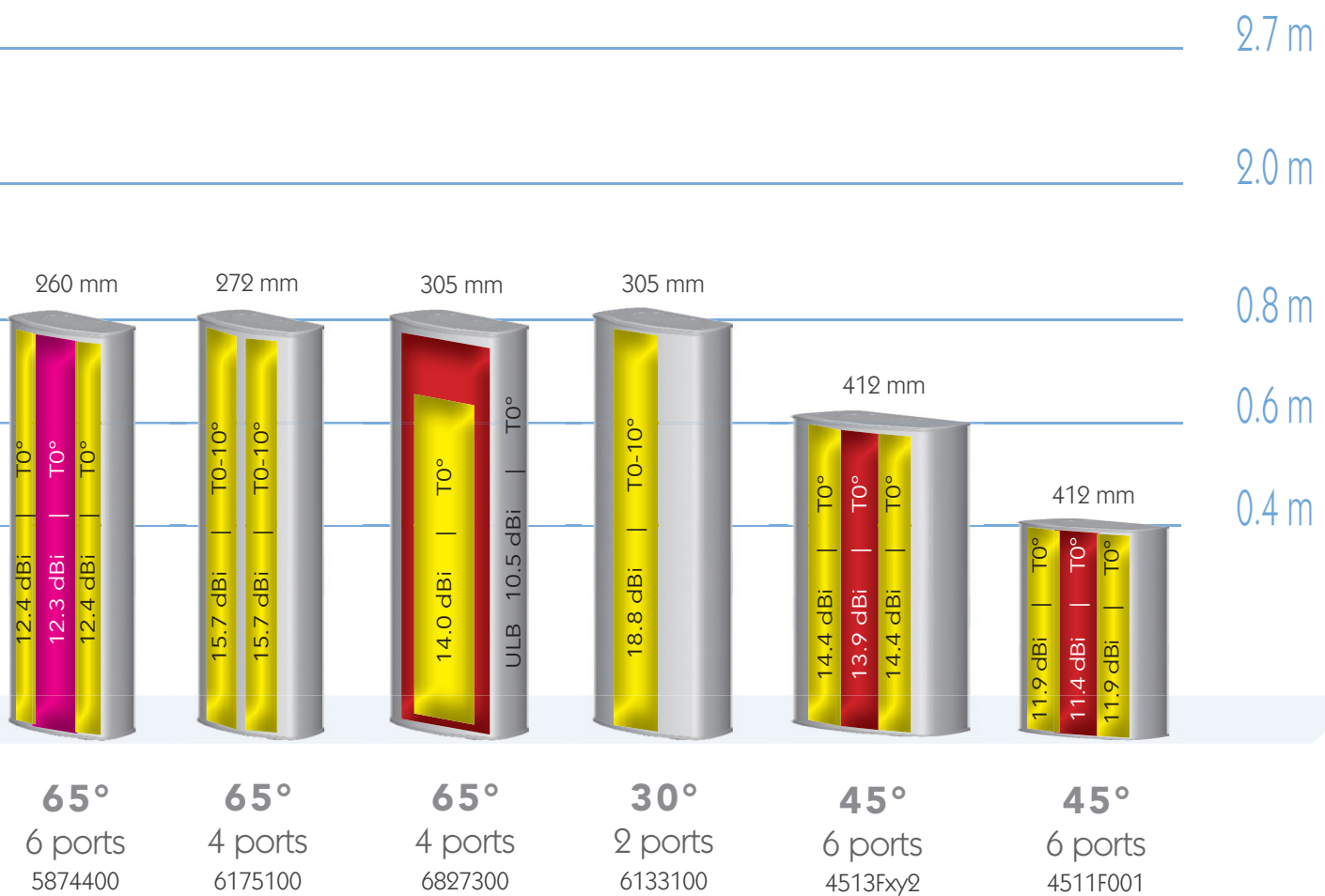

Slimline Panel Antennas / Small Cell Antennas

Extended Low Band (ELB) 790-960 MHz

Ultra Low Band (ULB) 698-960 MHz

Ultra Wide Band Array (UWB) 1695-2690 MHz

RET Control Systems

Amphenol offers patented fully integrated RET control units. The RET control units add no additional length to the antenna and are field replaceable. No calibration is required. Each RET is configured for the antenna and pre-commissioned at the factory. The electrical downtilt indicator is always visible and manual control is always possible. AISG v2.0 / 3GPP and Ericsson protocols. Compatible with most BTS vendors.

MDCU

One module will control the electrical downtilt of all the arrays of an antenna.

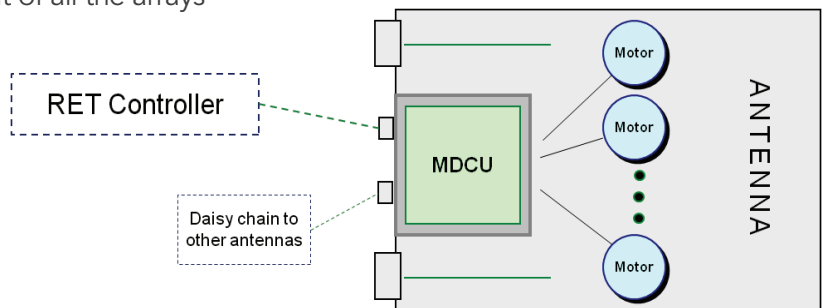

MDDU

Intended for site sharing. One module has two separate inputs, each controlling the electrical downtilt of the arrays of one operator.

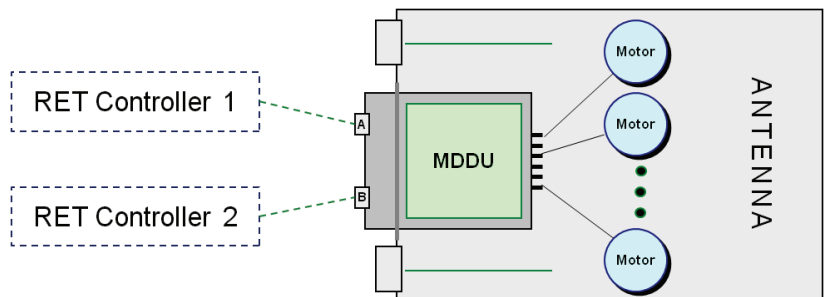
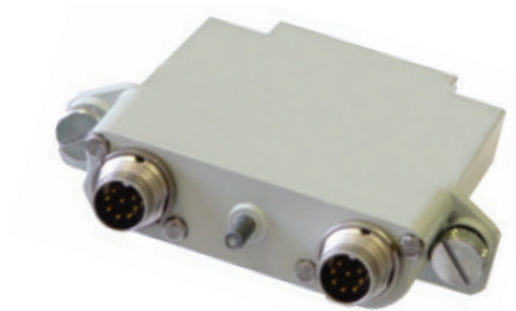

New 3rd Generation Integrated RET featuring new Manual Tilt Control and Tilt Indicators

As the demand for added connectivity of up to 20 ports has increased, so has the need for more space at the bottom of the antenna. To meet this need, without increasing the antenna package size, Amphenol Antenna Solutions has developed a new 3rd generation RET/VET system. This 3rd generation VET/RET system was designed with the objective of more efficiently utilizing the available space, while also making it more durable and easier for field operations. Exceeding ETS 300 019 compliance, the 3rd generation RET/VET system is able to withstand even more severe transportation and environmental conditions than before.

First implemented and available now on our TWINLINE series antennas, Amphenol Antenna Solutions will begin implementing the 3rd generation RET/VET system on our UltraLine antenna series in 2018.



RET Control Systems

Site Solutions

Amphenol Antenna Solutions is a single source for wireless infrastructure offering not only quality base station and Small Cell antennas, but also transmission line products like feeder cable, hybrid fiber, surge arrestors and connectors as well as RF peripherals like TMAs, combiners, couplers and splitters.

The company provides a comprehensive suite of solutions for virtually all applications and global frequencies, with product available from the top of the tower to the base station.

Feeder Cable



Whether it's a connection to a single component or a fully integrated RF transmission line system, Amphenol can supply your RF **Feeder Cable**. Select from flexible or superflexible, copper or aluminum with standard or fire retardant jackets in 1/4", 3/8", 1/2", 7/8", 1-1/4" or 1-5/8".

Jumper Cable Assemblies



Amphenol's premium **Jumper Cable** options are designed for outdoor applications under extreme conditions with high flexibility and small bending diameters. Cable assemblies are available in a variety of lengths and connector combinations and are waterproof per the IP68 water immersion testing standard.

Tower Mounted Amplifiers (TMAs)



Operators know that a cost-effective solution to maximizing site coverage and boosting call quality is through the use of **Tower Mounted Amplifiers (TMAs)**. Amphenol offers a global portfolio of single-band, multi-band and integrated filter designs to provide uplink amplification and support. Compatible power distribution units and Bias-Ts complete the solution.

Connectors & Adaptors



Amphenol has been a leading global interconnect solutions provider since 1932 and offers a multitude of products for wireless infrastructure. Our fast fitting, precision grade RF **Connectors & Adaptors** are available in 4.3/10, 7/16-DIN and N-Type with male and female interfaces. All are suitable for both copper and aluminum cable assemblies.

Splitters & Couplers

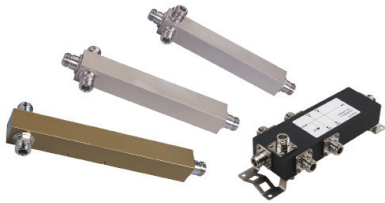

Amphenol offers **Splitters & Couplers** covering all wireless service bands. Products feature broadband characteristics with outstanding RF performance, high isolation, low insertion loss and low VSWR. Power splitters and couplers are available with 4.3/10, 7/16-DIN and N-Type connectors and are fully weatherproofed to satisfy class IP67 standards.

Lightning Protection



Protect your network by limiting voltage and energy from lightning strikes with Amphenol's **Lightning Protection/Surge Arrestors**. Available with 7/16-DIN or N-Type connectors in 1/4 wave, Gas Tube or a Hybrid type that combines the functions of the 1/4 wave and gas tube design.

Combiners

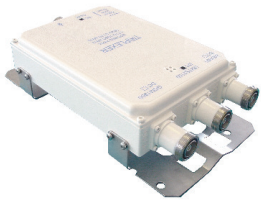

Amphenol's **Combiners** allow operators to combine multiple frequencies onto a single run of coax reducing overall costs, wind loads and weight in a streamlined arrangement. Diplexers, triplexers and quadruplexers are available for 2G, 3G and LTE systems and are designed for low insertion loss to ensure minimal impact on the overall system.

Bundled Corrugated Cable

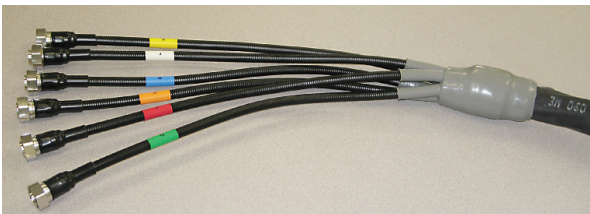

Amphenol's **Bundled Corrugated Cable** provides both material and labor savings as well as considerable improvements in ruggedness, system reliability and aesthetics for outdoor DAS systems. Complementing the bundled coaxial cable are custom accessories such as ground blocks, weather tight end caps and simple to use prep tools.

Hybrid Fiber Cable Assemblies



Save installation time and costs with Amphenol's **Hybrid Cables**. Hybrid Cables simplify tower cabling by providing power and optical connectivity in a single cable. For even faster installation, request factory-terminated assemblies with Amphenol connectors. Custom configurations of conductor counts, cable types or shielding are available with fast-turn delivery.

Accessories & Tools



All you need to get the job done - Feeder Clamps, Grounding Kits, Grounding Bars, Wall Entry Glands, Hangers and more.

INDEX

4511F001.....	12	6888670.....	6
4513Fxy2.....	12	6890100.....	6
5874400.....	12	6890103.....	10
5876400.....	7	6890300.....	6
5980300P-3.....	12	6890300N-3.....	10
5918300.....	5	6890400P.....	6
5920300.....	5	6896400.....	8
5920370P.....	4	6898400.....	8
5961400P.....	4	MDCU.....	13
5961470P.....	4	MDDU.....	13
5962300.....	5	High Band Panel Antennas.....	9
5963400P.....	5	RET Control Systems.....	13
5964300.....	5	Site Solutions.....	15
5965400P.....	5	Small Cell Antennas.....	12
5970300P.....	4	StreamLine Panel Antennas.....	8
5976600P.....	5	Tri-Sector Antennas.....	10
5978600P.....	5	TwinLine Panel Antennas.....	4
5980300P.....	4	UltraLine Panel Antennas.....	6
5980400P.....	4		
5980470P.....	4		
5980600P.....	4		
6133100.....	12		
6175100.....	12		
6176100.....	9		
6176103.....	11		
6177100.....	9		
6177103.....	11		
6177400.....	9		
6177700.....	9		
6798470.....	8		
6800400.....	8		
6827300.....	12		
6829300.....	7		
6861300.....	6		
6863300.....	7		
6876300.....	7		
6876400.....	8		
6878300.....	7		
6878303.....	11		
6880300.....	6		
6881300.....	6		
6888300.....	7		
6888303.....	11		
6888370.....	6		
6888370-3.....	11		

Amphenol Antenna Solutions

One Source. Global Site Solutions.



United Kingdom

Rutherford Drive, Park Farm South
Wellingborough, Northamptonshire
NN8 6AX United Kingdom
+44 (0) 1933-408408

France

ZI La Boitardière, Chemin du Roy
37400 Amboise France
+33 2 47 30 69 70

India

Plot No 3/4 B & 5A, CMDA's Industrial
Area Maraimalai Nagar, Tamil
Nadu INDIA
+044-37480304

Macedonia

Dimitar Vlahov 3
2300 Kocani
Republic of Macedonia
+389 33 270 433

North Carolina, USA

1123 Industrial Drive SW
Conover, NC 28613
USA
+1-828-324-6971

Mexico

Carretera Internacional Km 6.5
Col, Parque Industrial
Nogales, Sonora
Mexico C.P. 84094
+1-520-397-7117



info@amphenol-antennas.com
www.amphenol-antennas.com



info@amphenol-antennas.com
www.amphenol-antennas.com